

RH-S

Control valve with protection insert

DIN-EN: DN 15 - 600 / PN 10 - 40

ASME: NPS ½" - 24" / class 150

PT range: $-30 < T < 230/280^{\circ}\text{C}$, vacuum 10-8 mbar

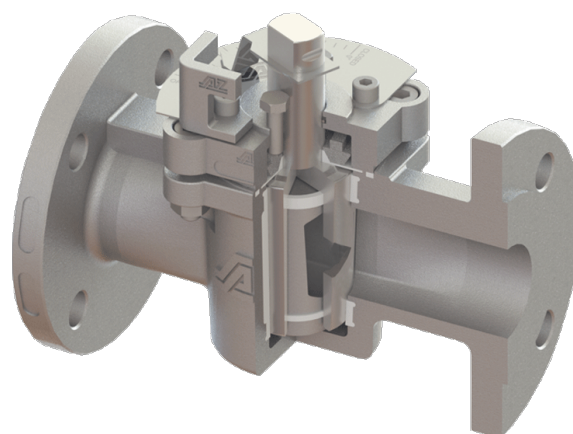

Design Features

Design Characteristics

- different KVS values
- individual control characteristics
- free passage possible with open valve
- equal percentage or linear characteristic line
- cost-effective automation
- readily reproducible control position

The construction of the RH and RH-A control valves is based on our standard cavity-free plug valve with PTFE-sleeve. A wide range of materials for housings, plugs, as well as for sleeves or linings are available for different areas of application. If required, the control valves can also be supplied with a heating jacket. The RH-S series is fitted with an additional internal protection insert. This protection insert is recommended for protecting the sleeves when there is a high flow velocity or pressure loss and/or solid-containing mediums. The protection insert can also contribute to an increase in service life.

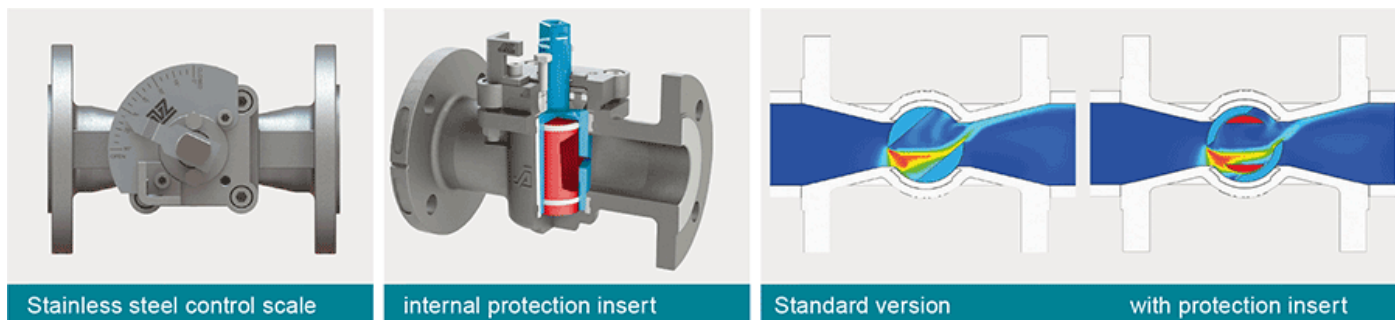

PT-Diagram

General Pressure-Temperature-Diagram

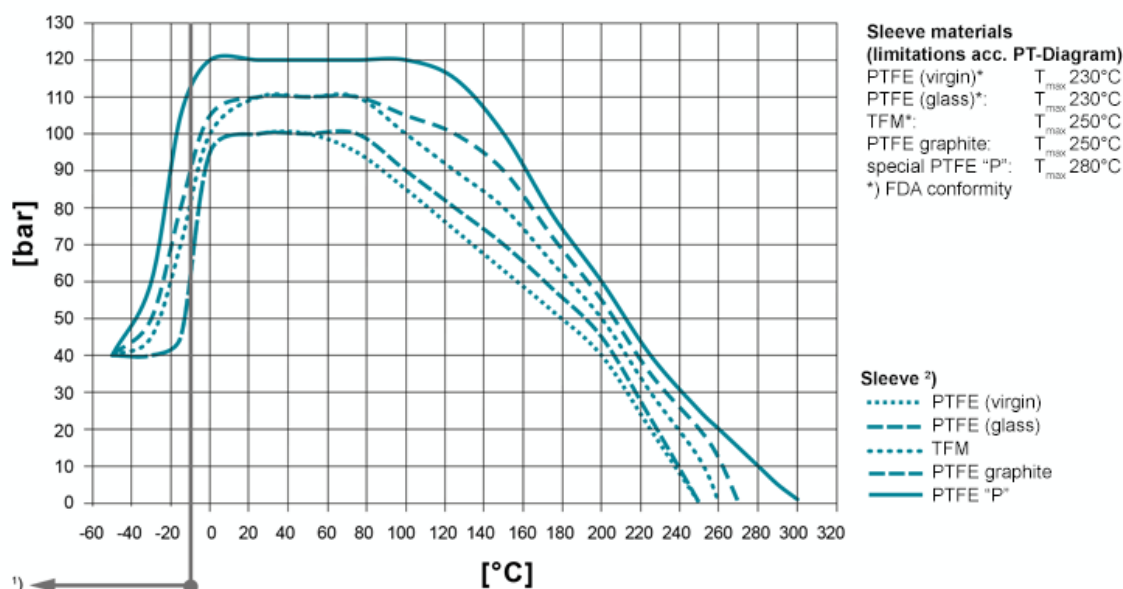

Operating temperatures < -30°C and > 220 °C have to be checked and approved by AZ according to the operating conditions. Besides the P/T value of the sleeve the limitations of the valve bodies also have to be considered. Please refer to the EN 12516-1 resp. ASME B16.34 in order to choose a proper pressure rating (PN/class). The shown values refer to austenitic stainless steel 1.4408 (A351 Gr. CF8M). 1) For operating temperatures below -10°C low temperature / austenitic steels are required. 2) Sleeve: There are different sleeve materials / compounds available.

Materials

Standard body materials

- Carbon Steel 1.0619, ASTM A216 WCB
- Stainless Steel 1.4408, ASTM A351 CF8M
- Stainless Steel 1.4308, ASTM A351 CF8
- Unalloyed stainless steel casting (low Temp.) 1.1138, LCC/LCB/A352 **Standard plug materials**

- Stainless Steel 1.4408, ASTM A351 CF8M
- Stainless Steel 1.4308, ASTM A351 CF8 **Special materials**
- Alloy
- Monel
- Nickel
- Zirconium
- Titan
- Tantal
- other materials on request

Sealing Systems

Standard sealing for all major applications;
T_{max} 230°C

Type STD

[read more \[...\]](#)

Firesafe sealing (API 607) with graphite
packing for additional
stem sealing; T_{max} 230°C

Type FS

[read more \[...\]](#)

Chemical sealing to prevent fugitive emission
of aggressive and toxic media
with PTFE packing for additional stem sealing;
T_{max} 230°C

Type CA

[read more \[...\]](#)

Firesafe safety sealing (API 607) for fluctuating
temperatures
with 3x graphite packing (adjustable) for additional
stem sealing; T_{max} 280°C

Type FSN

[read more \[...\]](#)

Firesafe safety sealing (API 607) for fluctuating
temperatures
with 3x graphite packing (live loaded disc springs) for
additional
stem sealing; T_{max} 280°C

Type FSN-SL

[read more \[...\]](#)

Chemical safety sealing for fluctuating temperatures
with 3x PTFE packing (adjustment) for additional stem
sealing;
T_{max} 230°C

Type CASN

[read more \[...\]](#)

Chemical safety sealing for fluctuation temperatures
with 3x PTFE packing (live loaded disc springs) for additional
stem sealing; T_{max} 230°C

Type CASN-SL

[read more \[...\]](#)

Port Forms

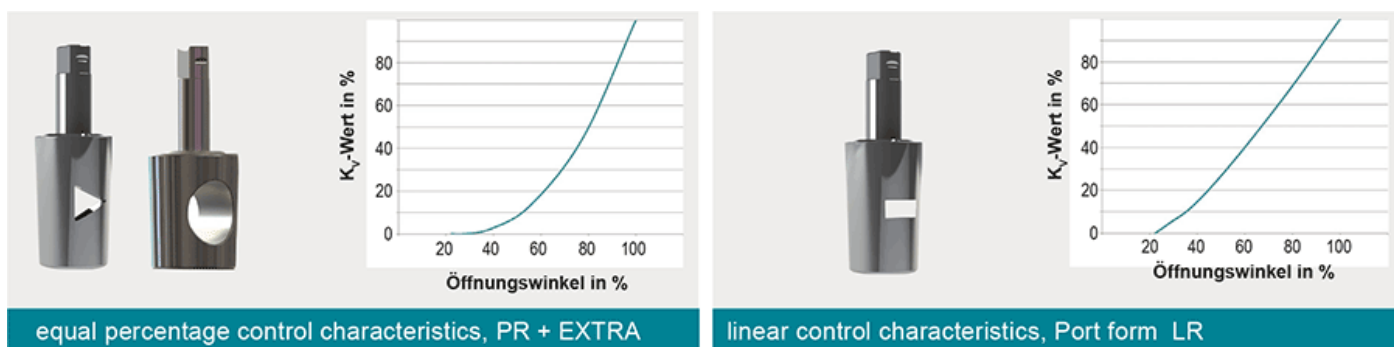

As standard, there are ten plugs forms available per valve size, consisting of five linear and five equal percentage control characteristics. Type “EXTRA” full bore plug valves with equal percentage control characteristics are recommended for very large flow rates (only RH and RH-S types). Furthermore, bespoke plug forms can be calculated and designed according to customer-specific requirements that combine, for example, control properties and free passage.

Characteristics

Type **RH-S,** **linear** **control** **characteristics**

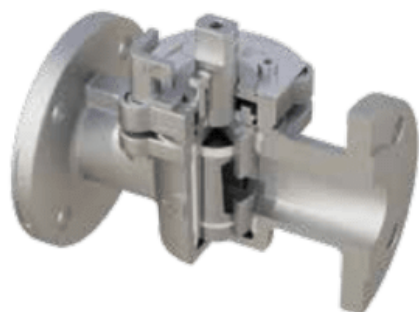

Type RH-S-LR

Plug with protection insert: linear control characteristics

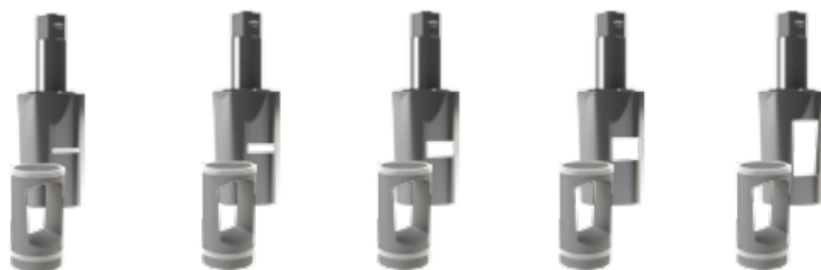

ASME / DIN EN	DIN	NPS	LR I K_{vs} value [m ³ /h]	LR II K_{vs} value [m ³ /h]	LR III K_{vs} value [m ³ /h]	LR IV K_{vs} value [m ³ /h]	LR V K_{vs} value [m ³ /h]
		DN 15	½	0,8	1,7	2,8	4,2
	DN 20	¾	0,5	1,3	2,5	3,9	4,8
	DN 25	1	0,9	1,7	2,7	5,0	9,1
	DN 32	1 ¼	1,6	3,2	5,2	9,8	19
	DN 40	1 ½	2,7	5,4	8,3	17	33
	DN 50	2	5,0	10	24	34	67
	DN 65	2 ½	8,6	19	29	55	100
	DN 80	3	8,3	17	25	49	88
	DN 100	4	8,2	17	25	44	73
	DN 100S	4S	21	44	68	144	322
	DN 125	5	29	61	95	188	330
	DN 150	6	29	58	91	164	284
	DN 200	8	57	117	186	342	600

Larger valves and higher operating pressures > PN 40 / class 300 on request
Due to geometric reasons partly threaded holes in flange drilling

Type **RH-S,** **equal** **percentage** **control** **characteristics**

Plug with protection insert: equal percentage control characteristics

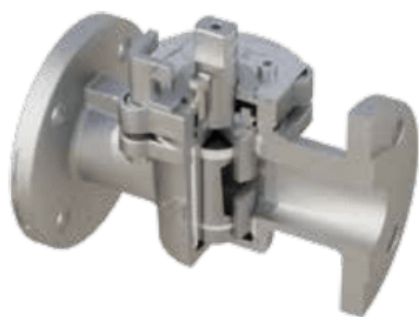

Type RH-S-PR



ASME / DIN EN	DIN	NPS	PR I	PR II	PR III	PR IV	PR V	EXTRA
			K_{vs} value [m ³ /h]	K_{vs} value [m ³ /h]	K_{vs} value [m ³ /h]	K_{vs} value [m ³ /h]	K_{vs} value [m ³ /h]	K_{vs} value [m ³ /h]
	DN 15	½	0,6	1,2	2,0	2,8	4,4	17
	DN 20	¾	0,4	0,9	1,6	2,3	4,1	32
	DN 25	1	0,9	1,8	2,8	4,0	6,1	63
	DN 32	1 ¼	1,6	3,3	5,3	7,9	10	102
	DN 40	1 ½	2,7	5,4	8,6	12	17	174
	DN 50	2	4,9	10	16	24	27	291
	DN 65	2 ½	8,4	19	29	42	61	512
	DN 80	3	7,9	16	26	37	53	852
	DN 100	4	7,9	16	25	35	51	1301
	DN 100S	4S	20	42	68	93	112	-
	DN 125	5	28	59	94	136	178	-
	DN 150	6	28	57	90	130	174	3004
	DN 200	8	56	115	184	261	331	5726

For geometric reasons, threads are used in the flange bores in a few cases **Model structure**

The data was determined by flow simulation and based on the VDI/VDE 2173 with a permissible deviation of +/- 10% (medium = water 20°C, pressure loss $\Delta p = 1$ bar). **Definition Kvs**

The Kvs value designates the maximum possible throughput for a valve with a 100% opening **Definition Kv**

The flow coefficient Kv [m³/h] is a specific volume flow for the following conditions:

- The pressure loss (Δp) via the valve is 10⁵ Pa (1 bar)
- The medium is water with a temperature between 278 K and 315 K (5°C to 40°C) **Definition Cv**

The flow coefficient Cv is a valve flow coefficient that does not correspond to S.I. units. It represents the number of U.S. gallons of water which flow through a valve with a pressure loss of 1 psi (68.95 mbar) at a temperature of 40°F to 100°F (4°C to 38°C) within a minute. $Cv = Kv/0,865$

Actuation

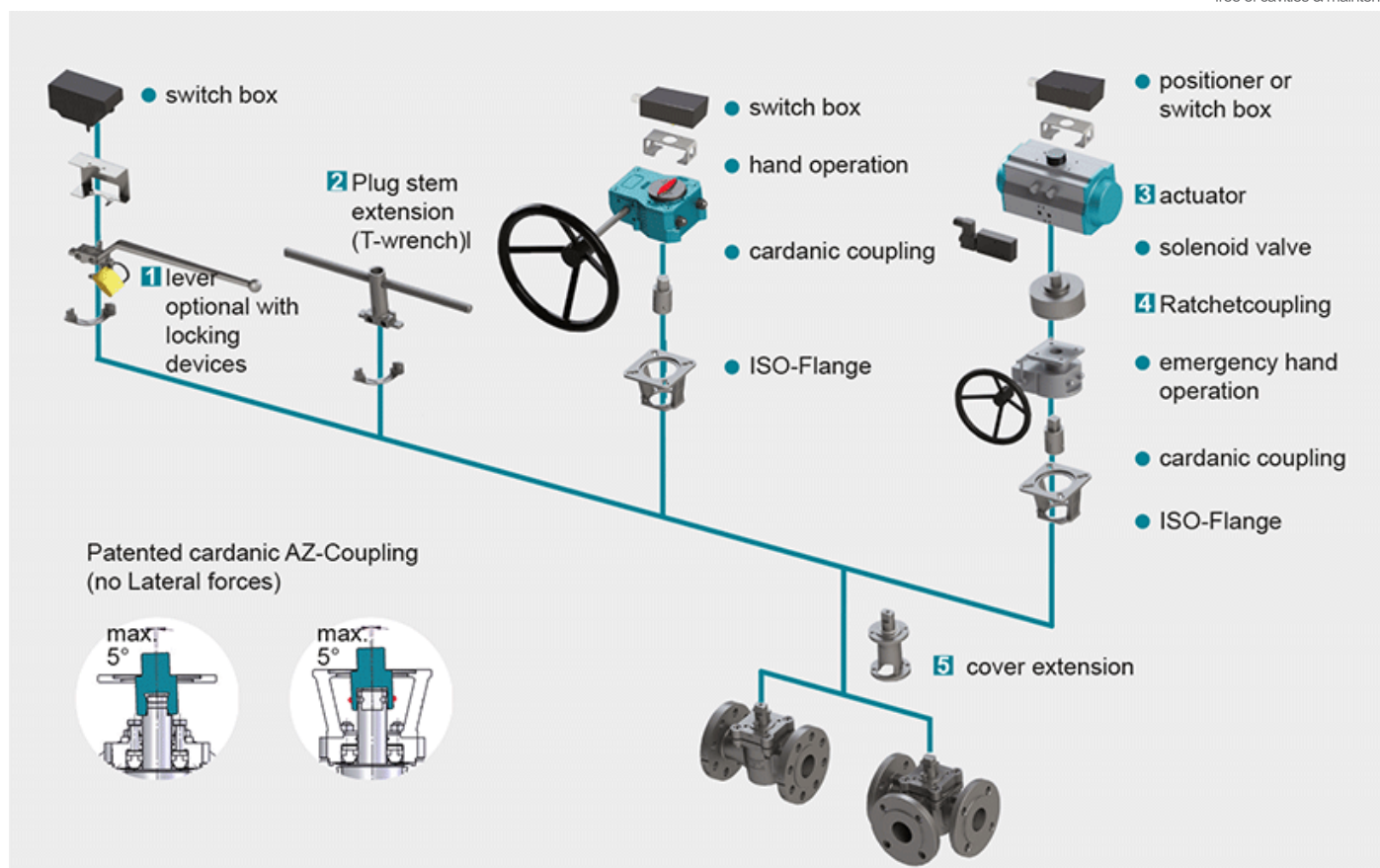

1 Locking Devices

Pilot valve combinations, pad lock eyelets, linear key conception, indexing plunger arrestor.

[read more \[...\]](#) 2 Plug stem extension

Solid construction in stainless steel with T-wrench, Standard extension 100 mm or 150 mm, non standard lengths are available on request

[read more \[...\]](#) 3 Actuators

Actuators for mounting-flange acc. to DIN ISO 5211

[read more \[...\]](#) NEW: Pneumatic actuator AIR GEAR for plug valves with high torque =150.000 Nm

[read more \[...\]](#) 4 Ratched coupling

To usw on multiport valves with standard 90° actuator for bigger switchpositions than 90°

[read more \[...\]](#) 5 Cover extension

Solid construction in stainless steel, Standard extension 100 mm or 150 mm high, non standard lengths are available on request . Hexagonal bolts on adjustment ring freely accessible. Note: Don't use with sealing FSN/FSN-SL and CASN/CASN-SL

[read more \[...\]](#)