

ISO-STANDARD A CA

Plug valve with chemical-resistant, vacuum-proof lining, with ISO top flange, sealing system Type CA

DIN-EN: DN 15 - 600 / PN 10 - 40

ASME: NPS ½" - 24" / class 150 - 300

PT range: $-30 < T < 210^{\circ}\text{C}$, vacuum tight

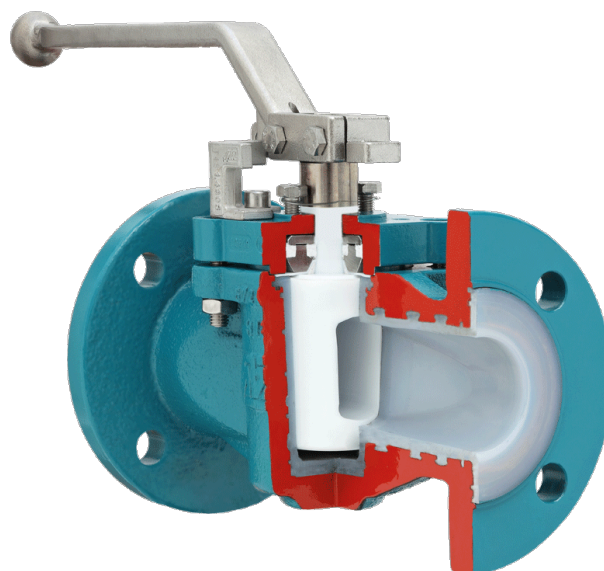

Design Features

Design Characteristics

- free of cavities
- maintenance free - self lubricating
- mounting-flange for actuators acc. to DIN ISO 5211
- easy accessible adjustment of the plug, even with mounted actuator
- with chemical resistant lining - thickness min. 3 mm vacuum tight
- fugitive emission resp. clean air act certified (TA - Luft 2002 approval)
- Directive 2014/68/EU
- FDA conformity

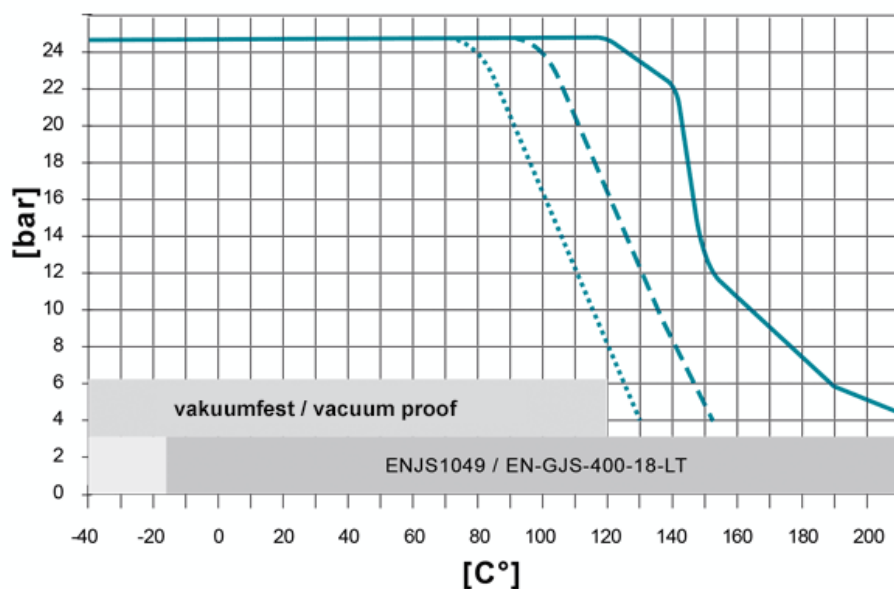

PT-Diagramm

General Pressure-Temperature-Diagram



Lining materials		Tmax
Body	Plug	
PFA	PTFE	210°C
PFA/FEP	PFA	150°C
PFA	Special material	210°C
PFA cond.	PFA conductive	125°C

Standard lining materials::
PFA (body) and PTFE (plug)

Lining materials Body / Plug	
	PFA or FEP / PTFE
	PFA / PFA
	PFA / FEP

The specified values depend on the respective application (medium). Operating temperatures under -20°C only with body material 1.4408 or low-temperature steel. High pressure resistance / temperature resistance on request, e.g. PN 40. Sleeve: There are different sleeve materials / compounds available.

Materials

Standard body materials

- Ductile cast iron ENJS 1049, ASTM Gr 60-40-18 / A395 **Standard plug materials**

- Stainless Steel 1.4308, ASTM A351 CF8

- Ductile cast iron ENJS 1049, ASTM Gr 60-40-18 / A395 **Special materials**

- Carbon Steel 1.0619, ASTM A216 WCB

- Stainless Steel 1.4408, ASTM A351 CF8M

- Unalloyed stainless steel casting (low Temp.) 1.1138, LCC/LCB/A352 **Lining materials**

- Body: PFA, PFA-conductive, FEP

- Plug: PTFE, PFA, PFA-conductive, FEP

Sealing Systems

Chemical sealing to prevent fugitive emission of aggressive and toxic media with PTFE packing for additional stem sealing; T_{max} 230°C

Type CA

[read more \[...\]](#)

Port Forms



AZ plug valves are fitted with cast, rust proof position indicators
The position indicator is securely welded to the plug to prevent it from working loose.

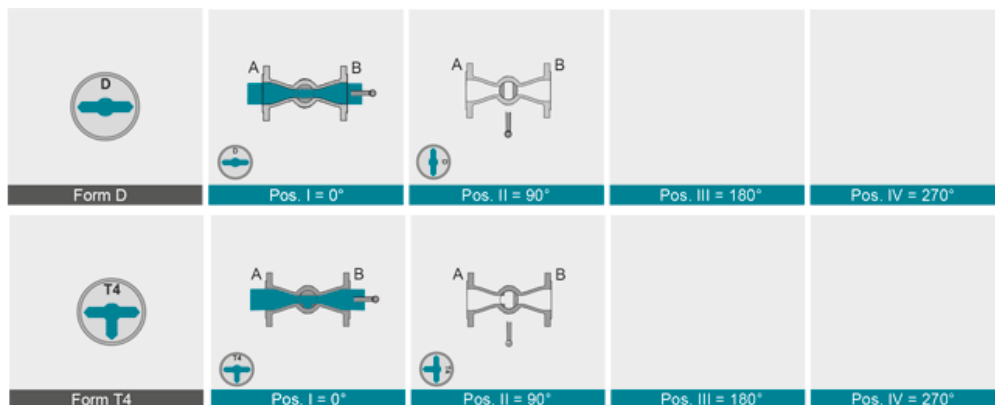

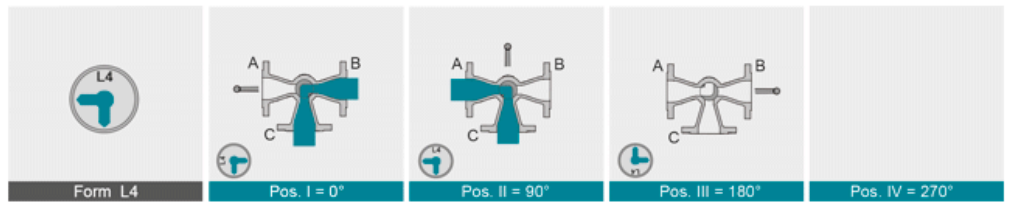
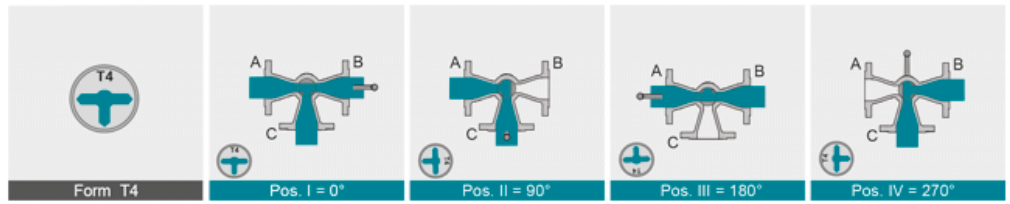
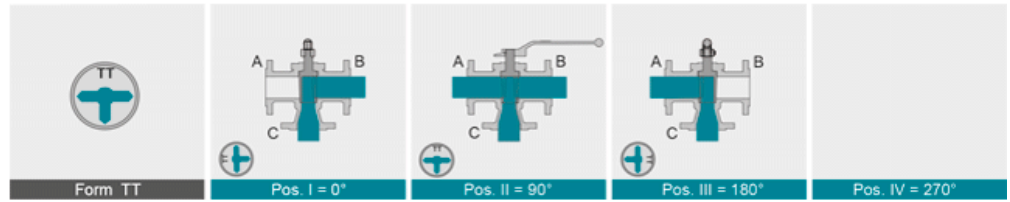
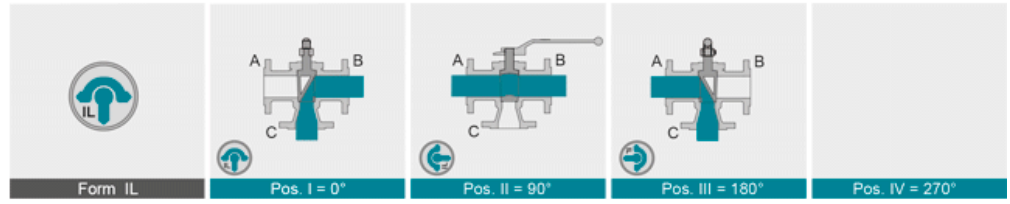
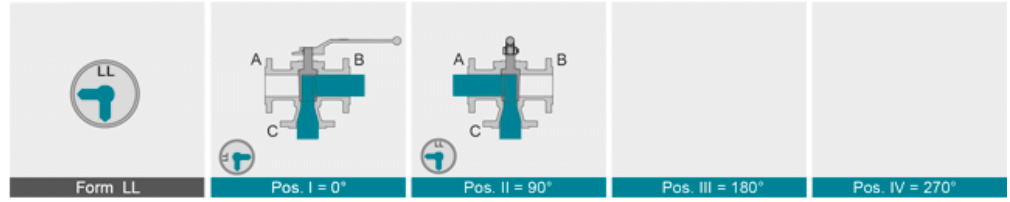
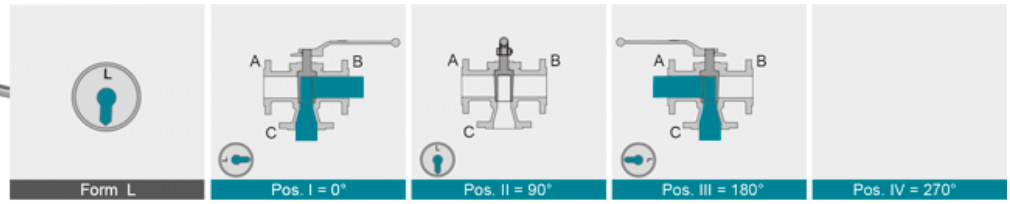
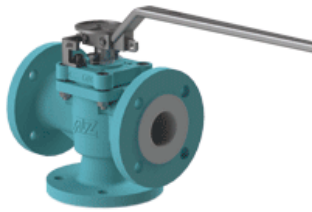

Dimensions

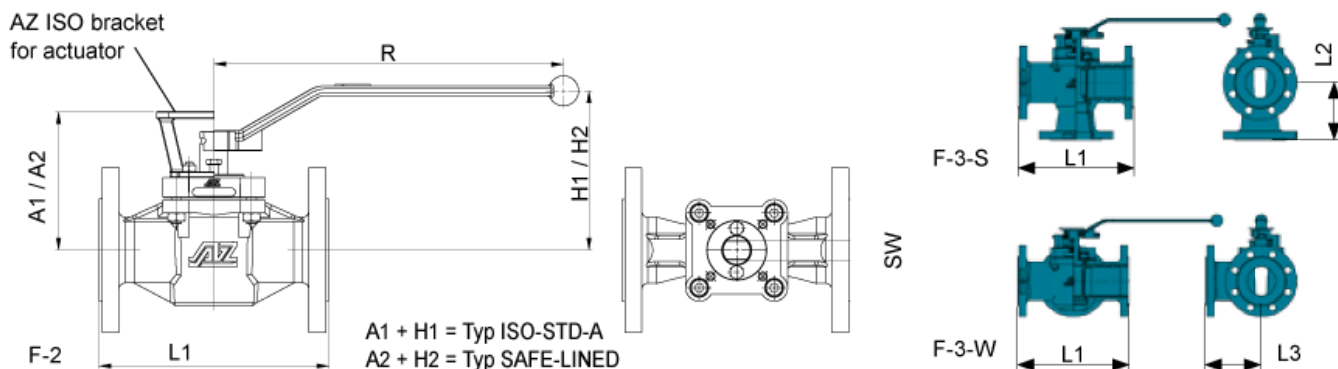

DIN EN 1092/1 / 568-1	DN	PN	L1 [mm]	L2 [mm]	L3 [mm]	A [mm]	H1 [mm]	H2 [mm]	R1 [mm]	H1 [mm]	DIN-ISO bracket	SW [mm]	torque.* [Nm]	weight [kg]	K _{vS} value [m³/h]	C _v value [US.gal/min]
	15	10-40	130	*	*	88	98	**	200	**	F05	11	40/--	3,8	7,1	8,2
20	10-40	150	75	75	88	98	**	200	**	F05	11	40/--	4,0	5,8	6,7	
25	10-40	160	80	80	94	110	**	200	**	F07	14	90/60	6,5	32	37	
32	10-40	180	90	90	102	117	**	320	**	F07	14	90/60	7,5	51	59	
40	10-40	200	100	100	109	124	**	320	**	F07	14	160/80	10	79	92	
50	10-40	230	115	115	139	160	**	420	**	F07	19	250/120	12	127	147	
65	10-16 25-40	290	*	*	158	170	**	600	**	F10	22	400/260	20	179	207	
80	10-40	310	155	155	158	170	**	600	**	F10	22	400/260	20	246	285	
100	10-16 25-40	350	175	175	158	170	**	600	**	F10	22	400/260	30	203	203	
ASME B 16.5 / 16.10	NPS	L1 [mm]	L2 [mm]	L3 [mm]	A [mm]	H1 [mm]	H2 [mm]	R1 [mm]	H1 [mm]	DIN-ISO bracket	SW [mm]	torque.* [Nm]	weight [kg]	K _{vS} value [m³/h]	C _v value [US.gal/min]	
	½	150	108	**	88	110	**	200	**	F05	11	40/--	2,7	7,7	9,0	
	300	140	**	**									3,8			
¾	150	117	64	64	88	110	**	200	**	F05	11	40/--	3,2	6,4	7,4	
	300	152	83	83									4,3			
1	150	127	**	**	94	110	**	200	**	F05	11	90/60	3,5	35	41	
	300	165	**	**							14		6,0			
1¼	150	140	89	89	102			320		F07	14	90/60	7,5	56	65	
	300	178	**	**									8,5			
1½	150	165	**	**	109	124	**	320	**	F07	14	160/80	9	87	101	
	300	190	**	**									10			
2	150	178	**	**	139	160	**	420	**	F07	19	250/120	13	140	162	
	300	216	**	**									16			
2½	150	190	**	**	158			600		F10	22	400/260	16	197	228	
	300	241	**	**									19			
3	150	203	**	**	158	170	**	600	**	F10	22	400/260	18	271	314	
	300	282	**	**									23			
4	150	229	154	**	158	170	**	600	**	F10	22	400/260	26	223	223	
	300	305	**	**									31			

ISO flange instructions, weights and KVS values for straight-way valves

*) Maximum breakaway torque $M_{d_{breakaway}} [Nm]$ for F-2 and F-3-S ISO standard A depending on material combinations (PFA+PFA / PFA+PT-FE). All data incl. 100% safety factor Breakaway torques for valves - types F-4 and F-3-W on request

***) on request

Due to geometric reasons partly threaded holes in flange drilling

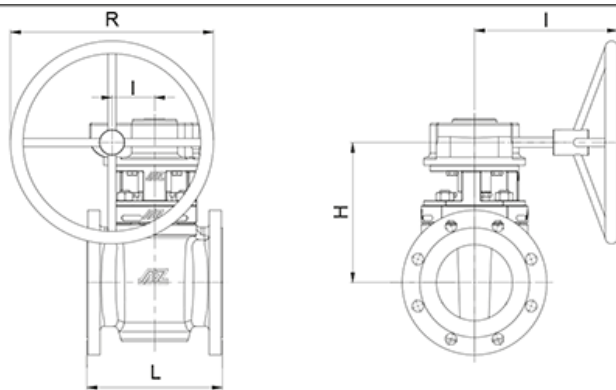

F-2 ISO-STANDARD-A



F-3-S ISO-STANDARD-A



F-3-W ISO-STANDARD-A



	DIN EN 1092/1 / 588-1										ASME B 16.5 / 16.10						
	DN	PN	L1	L2	L3	E	R	H	I	Gear	ISO 5211 flange	dihe-dron	torque* [Nm]	weight [kg]	K _{vs} -value [m ³ /h]	C _v -value [US.gal/min]	
DIN EN 1092/1 / 588-1	100S	10-16	350	**	**	84	400	230	290	Q1500-S	F16	36	600/350	32	447	517	
		25-40	350	**	**	84	400	230	290	Q1500-S	F16	36	600/350	32	447	517	
	125	10-16	325	**	**	84	400	260	290	Q1500-S	F16	36	1200/900	74	358	414	
		25-40	325	**	**	84	400	260	290	Q1500-S	F16	36	1200/900	78	358	414	
	150	10-16	350	200	200	84	400	265	290	Q1500-S	F16	36	1200/900	85	822	951	
		25-40	350	200	200	84	400	265	290	Q1500-S	F16	36	1200/900	87	822	951	
	200	10-16	400	**	**	96,5	600	320	350	Q2000-S	F16	36	2600/--	119	1727	1997	
		25 40	400	**	**	96,5	600	320	350	Q2000-S	F16	36	2600/--	131	1727	1997	
	250	10 16	450	**	**	117,5	600	352	465	Q5000-S	F16	36	3200/--	195	2052	2373	
		25 40	450	**	**	117,5	600	352	465	Q5000-S	F16	36	3200/--	259	2052	2373	
	300	10 16	500	**	**	117,5	600	340	465	Q5000-S	F16	36	3200/--	253	1707	1973	
		25 40	500	**	**	117,5	600	340	465	Q5000-S	F16	36	3200/--	274	1707	1973	
ASME B 16.5 / 16.10	NPS	Class	L1	L2	L3	E	R	H	I	Gear	ISO 5211 flange	dihe-dron	torque* [Nm]	weight [kg]	K _{vs} -value [m ³ /h]	C _v -value [US.gal/min]	
	4"S	150	254	154	154	84	500	230	328	Q1500-S	F16	27	600/350	27	492	569	
		300	325	**	**	84	500	230	328	Q1500-S	F16	27	600/350	32	492	569	
	5"	150	254	**	**	118	500	260	363	Q1500-S	F16	27	1200/900	61	394	455	
		300	325	**	**	118	500	260	363	Q1500-S	F16	27	1200/900	78	394	455	
	6"	150	267	**	**	118	500	265	363	Q1500-S	F16	27	1200/900	66	904	1046	
		300	403	**	**	118	500	265	363	Q1500-S	F16	27	1200/900	77	904	1046	
	8"	150	292	**	**	138	500	320	440	Q2000-S	F16	36	2600/--	103	1900	2197	
		300	419	**	**	138	500	320	440	Q2000-S	F16	36	2600/--	138	1900	2197	
	10"	150	330	**	**	138	500	352	440	Q5000-S	F16	36	3200/--	140	2257	2610	
		300	457	**	**	138	500	352	440	Q5000-S	F16	36	3200/--	176	2257	2610	
	12"	150	356	**	**	138	500	340	440	Q5000-S	F16	36	3900/--	168	1877	2170	
300		502	*	*	138	500	340	440	Q5000-S	F16	36	3900/--	187	1877	2170		

For geometric reasons, threads are used in the flange bores in a few cases

ISO flange instructions, weights and Kvs values for straight-way valves

*) Maximum breakaway torque MD breakaway [Nm] for F2 and F3S ISO STANDARD A depending on material combinations (PFA+PFA / PFA+PTFE). All data incl. 100% safety factor. Breakaway torques for valves – tapes F-4 and F3W on request

**) on request

For geometric reasons, threads are used in the flange bores in a few cases

ISO flange instructions, weights and Kvs values for straight-way valves

*) Maximum breakaway torque MD breakaway [Nm] for F2 and F3S ISO STANDARD A depending on material combinations (PFA+PFA / PFA+PTFE). All data incl. 100% safety factor. Breakaway torques for valves – tapes F-4 and F3W on request

Actuation

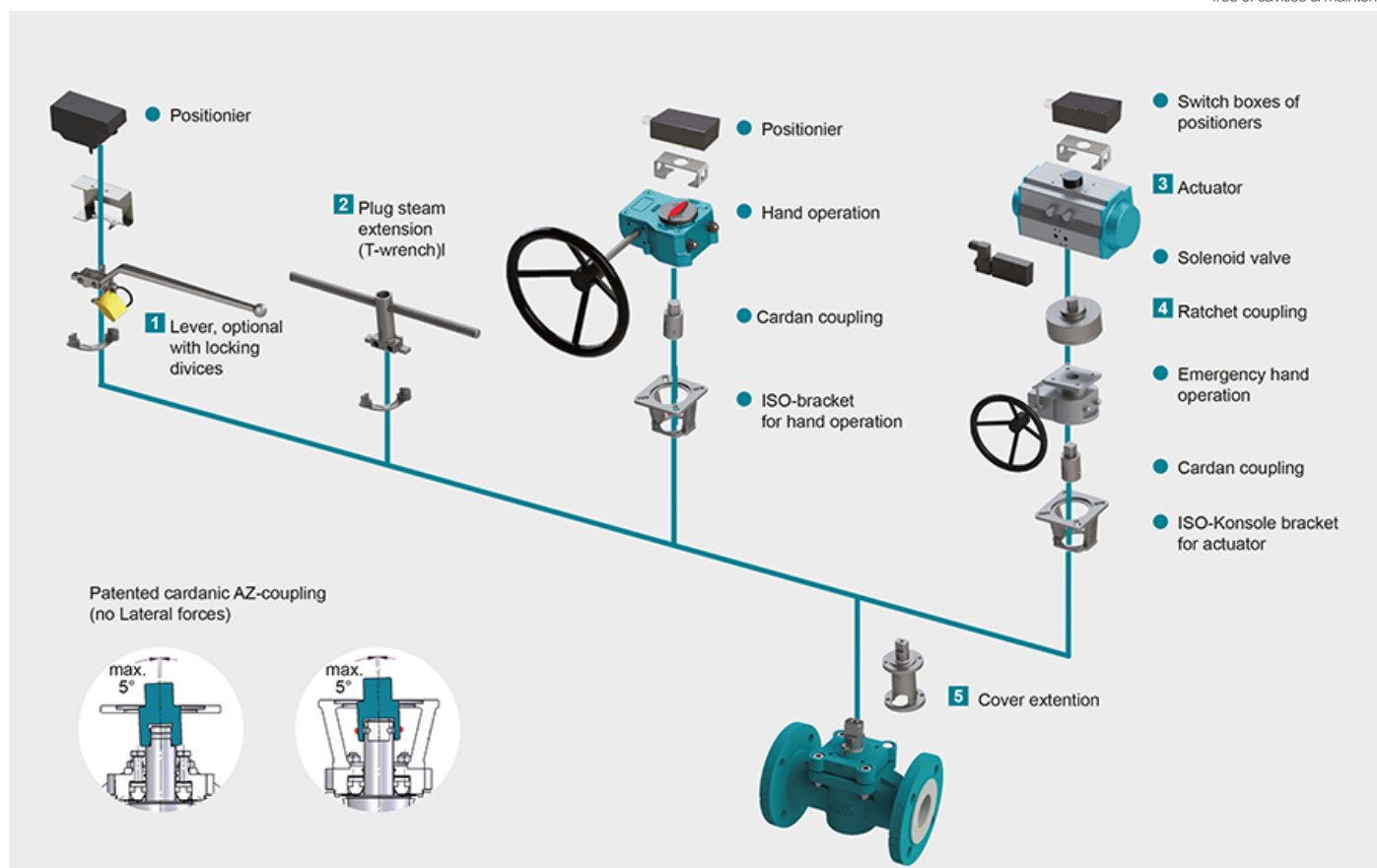

1 Locking Devices

Pilot valve combinations, pad lock eyelets, linear key conception, indexing plunger arrestor.

[read more \[...\]](#) 2 Plug stem extension

Solid construction in stainless steel with T-wrench, Standard extension 100 mm or 150 mm, non standard lengths are available on request

[read more \[...\]](#) 3 Actuators

Actuators for mounting-flange acc. to DIN ISO 5211

[read more \[...\]](#) NEW: Pneumatic actuator AIR GEAR for plug valves with high torque =150.000 Nm

[read more \[...\]](#) 4 Ratched coupling

To usw on multiport valves with standard 90° actuator for bigger switchpositions than 90°

[read more \[...\]](#) 5 Cover extension

Solid construction in stainless steel, Standard extension 100 mm or 150 mm high, non standard lengths are available on request . Hexagonal bolts on adjustment ring freely accessible. Note: Don't use with sealing FSN/FSN-SL and CASN/CASN-SL

[read more \[...\]](#)